



DC 90

DEEP CYCLE BATTERY
12V | 90Ah | 100h

Electrical Specifications

Nominal voltage	12V
Rated capacity	90Ah at C ₁₀₀
Separator	PE
Cycle life in relation to depth of discharge	700 cycles at 30 % DoD
	400 cycles at 50 % DoD
	280 cycles at 80 % DoD
	180 cycles at 100 % DoD

Mechanical Specifications

Measurements (L x W x H)	278 x 175 x 190mm
Approx. weight	18.6kg
Terminal type	Round
Case Material	PP
Lid Material	PP

Charging and Discharging

Capacity C ₁₀₀	90Ah
Capacity C ₂₀	80Ah
Capacity C ₁₀	75Ah
Capacity C ₅	60Ah
Max. charge current	16A
Max. discharge current	794A (5 seconds)

Temperature Specifications

Discharge Temperature	-15 to 50°C
Charge Temperature	0 to 40°C
Storage Temperature	-15 to 50°C
Normal Operating Temperature	25 ± 5°C

Measurements

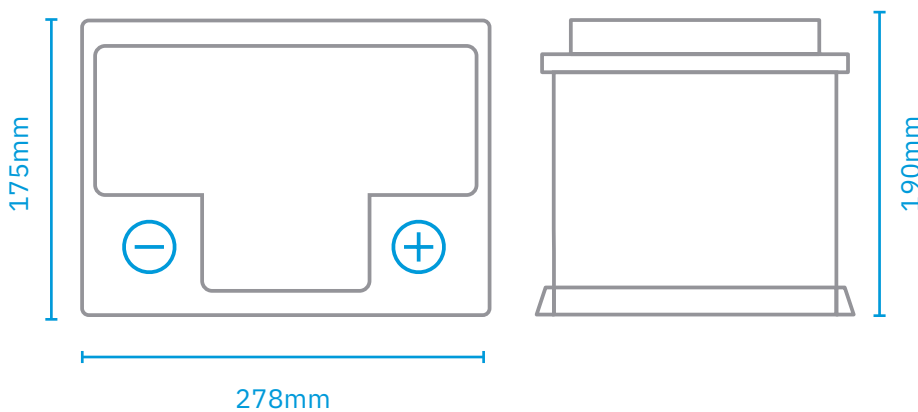

Discharge Characteristics Curve

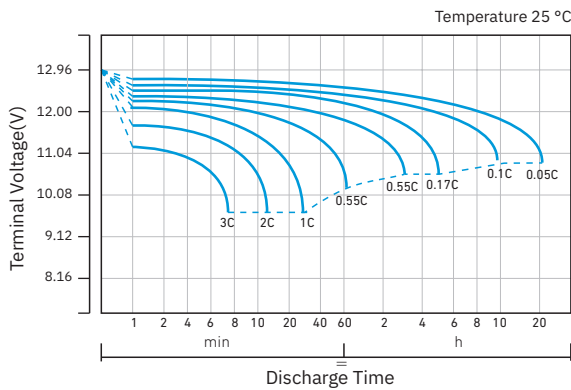

Charge Characteristics Curve For Cycle Use (IU)

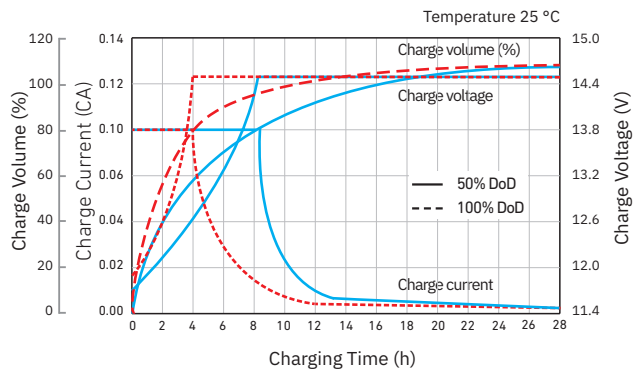

Relationship of Cycle Life and DoD

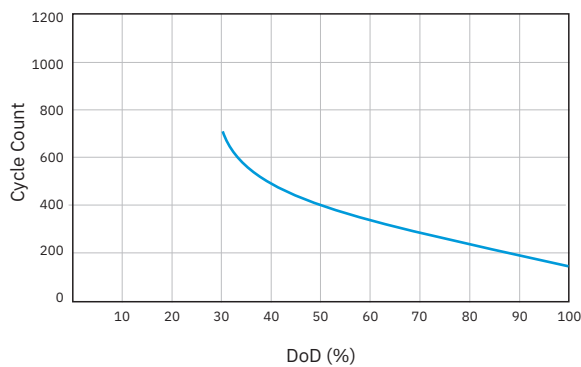

Relationship of Charge Voltage and Temperature

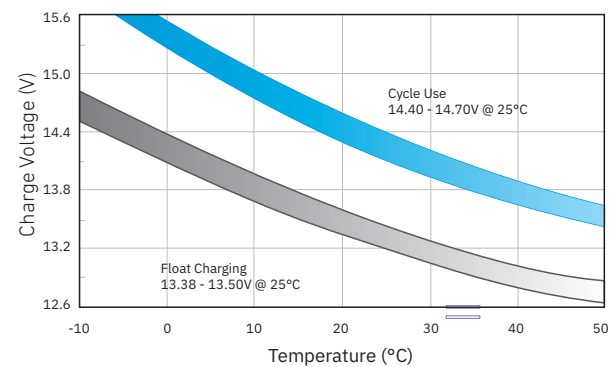

Temperature Effects on Capacity

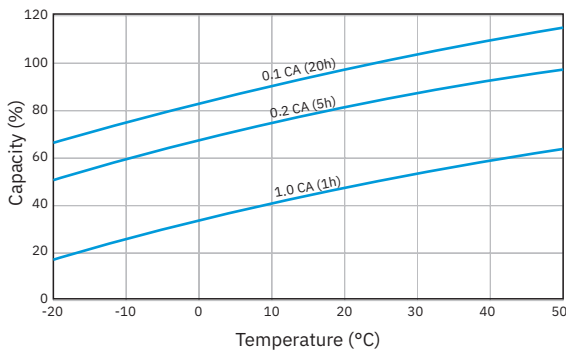

Storage Characteristics

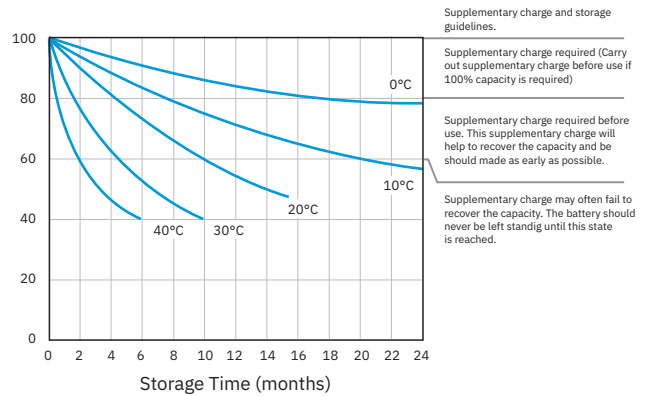

Effect of Temperature on Long-Term Life

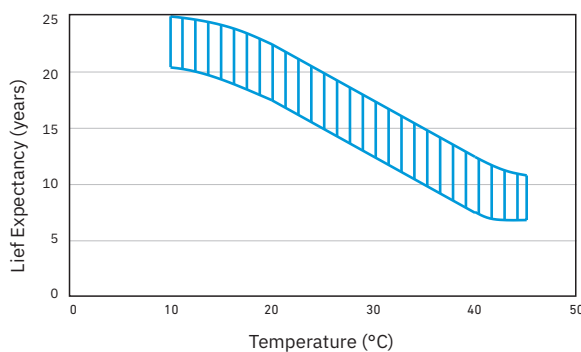

Relationship of OCV and State of Charge

